

IRENEUSZ BEMKE, ROMUALD ZIELONKO

Gdansk University of Technology, Faculty of Electronics
Telecommunications and Informatics
Gdańsk, Poland
email: bemke@merkury.perfect.net.pl, zielonko@eti.pg.gda.pl

IMPROVEMENT OF GLASS BREAK ACOUSTIC SIGNAL DETECTION VIA APPLICATION OF WAVELET PACKET DECOMPOSITION

The main subject of the authors' research are non-contact methods of glass break detection based on analysis of the acoustic signal generated during the event. This problem has essential meaning for modern cost-effective alarm systems, particularly those installed into big buildings. The main difficulties of the matter are: transient, stochastic character of the signal, great number of similar sounds (false signals, mainly accidental glass hits without break) and variability of many parameters (e.g. size and thickness of the glass pane, distance to detector). During research the authors developed a detection algorithm based on Wavelet Transformation (WT) and found some measures allowing to extract distinctive features from the signal and their classification. The obtained detection efficiency (>90%) is satisfactory, but immunity against false signals (near to 80%) does not reach the assumed level. Because Wavelet Packet Decomposition (WPD) provides a more detailed analysis in the frequency domain than WT and does better extraction of time-frequency interdependencies of the signals, the authors decide to use it for algorithm improvement.

This paper discusses results of WPD application to improve system performance and to increase the immunity against false signals. In the paper, on the background of a description of the problem, a theoretical basis of the WPD method and results of the investigation of its effectiveness are presented.

Keywords: Wavelet Packet Decomposition, signal analysis, glass breaks detection.

1. INTRODUCTION

Nowadays most homes and flats are protected by advanced alarm systems. These installations are usually equipped with a lot of detectors and signaling devices. One of their most important elements is the glass break detector. Earlier break sensors were often based on detection of strong vibrations of the glass pane being broken, but such solution needed an individual detector on every window, what made systems complicated. Modern units use non-contact detection methods based on acoustic signal analysis.

¹ Received: October 14, 2008. Revised: November 25.

The main advantages of these methods are lack of wires and free number of simultaneously monitored windows. Although those features make them cheap and flexible in application, the stochastic character of analyzed phenomena, their non-linearity, great number of varied parameters and material features make this problem very complicated. Moreover, solutions of the problem are restricted by strong standard requirements. For example the German VdS standard [12] requires over 90% of break detection efficiency (detectability), and at the same time near 100% of resistance to strictly defined false signals. Note that more important than detectability is the resistance (immunity) to false signals. This is due to costs of false alarms. Additionally false alarms decrease the vigilance of guards (it is one of sabotage methods).

The main difficulty of the task consists in the great number of signals received by the detector – mechanically and thermally stimulated glass breaks (true signals), environment sounds, sabotage sounds, human voices, traffic sounds and other false signals (often with a frequency spectrum similar to true signals). Moreover a detector receives not only direct sound, but also its reflected and interfered copies. Fig. 1 shows a typical method of break detector installation and some ways of acoustic signal propagation.

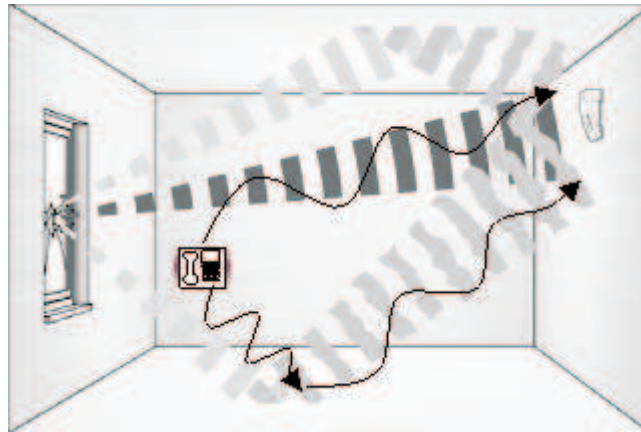

Fig. 1. Typical method of detector installation and different ways of signal propagation.

To detect the phenomena by analyzing the generated sound it is important to know the nature of the process. Fig. 2 shows a glass pane in each particular step of the four-stage model of the process proposed by Tlaga [2], [11]. The time course of its acoustic signal is presented at the bottom of the figure. Stage 1 – directly after smash, glass accumulates the energy and consumes it by vibrations – behaves like the surface of water. If there was enough energy in the hit, glass begins to crush (stage 2). In fact, usually the energy is so huge that glass breaks within the first “wave”. From this moment, damages grow rapidly (stage 3) and regardless of energy and glass structure, a particular pane can “explode” or stay crushed only. Usually it explodes, so finally small pieces of glass fall down on the floor, which ends the process (stage 4).

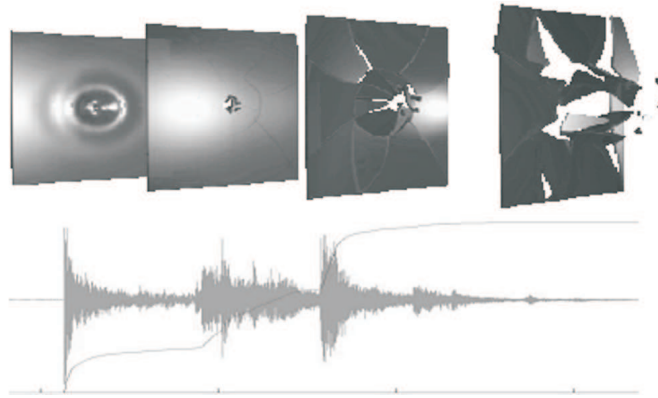

Fig. 2. Visualization of four-stage glass pane breaking process.

If the energy of stage 1 is not high enough to break the glass, the pane loses it by vibrations. In consequence a false signal generated during a weak hit consists of the first stage only. An example of such a signal is presented in Fig. 3.

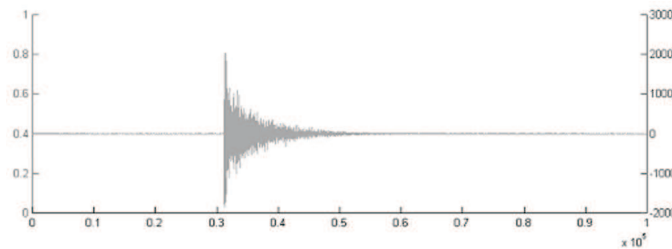

Fig. 3. Typical acoustic signal of a smashed but not broken glass pane.

A medium glass break acoustic signal is about 1-2 seconds long and has very wide bandwidth (from Hz to hundreds of kHz) [11], but most methods analyze only a narrow band between 3-6 kHz. Many known non-contact methods base on detection of a few acoustic frequencies [5], but these methods do not allow to fulfill standards, because time-frequency relations of the signal have essential meaning [2]-[4], [10].

The authors proposed a novel JTFA (Joint Time Frequency Analysis) approach, based on Wavelet Transformation (WT) and some distinctive measures to analyze the input signal [2], [3]. The WT is used for two purposes: firstly, it divides the signal into a few separate bands; secondly, WT transforms every band into the orthogonal basis of wavelet coefficients (details and approximations). During the research the authors have found some distinctive features of the signal allowing its effective classification (phase and energy dependences), proposed algorithms optimized for embedded systems and tested them in the Matlab environment using real signals. The obtained detectability (over 90%) meets the VdS standard, but 80% of resistance to false signals does not.

It has been found that a more detailed analysis in the frequency domain is required to improve the performance of the system, so the authors decided to apply Wavelet Packets Decomposition (WPD) for extraction of signal features. The first results have been presented at the IMEKO TC-4 Symposium 2008, Florence. This article is an extended and updated version of that presentation [4].

2. WAVELET TRANSFORMATION AND WAVELET PACKET DECOMPOSITION

Wavelet Transformation is a modern mathematical tool for signal analysis. Its main advantage is the possibility of base function selection (including its generation) which allows to extract different signal features and represent the analyzed data in many different forms [1], [7]-[10]. WT is self-scaling and has good resolution in time and frequency domains. Its results can be seen as a correlation between the analyzed signal and the set of orthogonal functions called wavelets, generated by scaling and translating of a given mother wavelet. In fact the function has to fulfill only few conditions to be a mother wavelet [1], [5], [13], first of all it should be well localized in time and frequency domains, what makes WT useful for the analysis of non-stationary signals. The Continuous Wavelet Transformation (CWT) is expressed by the formula (1):

$$CWT(a, b) = \frac{1}{\sqrt{a}} \int \Psi^* \left(\frac{t-b}{a} \right) \cdot s(t) dt, \quad (1)$$

where: $\psi^*(t)$ is the complex conjugate of wavelet function $\psi(t)$, a, b dilatation and translation coefficients, and $s(t)$ is the analyzed signal. In the discrete time domain the Discrete Wavelet Transformation (DWT) is used:

$$DWT_x(m, n) = \frac{1}{\sqrt{2}} \int_{-\infty}^{\infty} \Psi^* (2^m \tau - n) s(\tau) d\tau. \quad (2)$$

The set of functions well localized in the frequency domain spans some frequency range. From this point of view wavelets can be seen as a special filter bank. In practical applications usually only two filters created from a mother wavelet and its scaling function consist a Wavelet Filter Bank, called quadrature mirror filters [5], [13]. By selecting the mother wavelet (filter) it is possible to obtain different features of the signals [7]-[10].

Computation is based on the iterative Mallat's algorithm (Fig. 4a.) with dyadic scaling, usually applied for MRA. The signal is convolved with low-pass and high-pass filters and the results represent low- and high- frequency parts of the analyzed data (approximations and details). This computation process is known as Fast Wavelet Transformation (FWT) [1], [13] and has small computation complexity, for a one-dimensional signal proportional to its length. Formula (3) describes the processing.

$$\begin{aligned}
 a_{j+1}[n] &= \downarrow_2 [a_j[n] * h[k]] = \sum_k a_j[2n - k]h[k], \\
 d_{j+1}[n] &= \downarrow_2 [a_j[n] * g[k]] = \sum_k a_j[2n - k]g[k],
 \end{aligned}
 \tag{3}$$

where: $a_{j+1}[n]$ represent the approximations, and $d_{j+1}[n]$ the details of the input signal $a_j[n]$ convolved with filters $h[k]$ and $g[k]$. In consequence an octave-band filter bank is created, with time-frequency resolution schematically presented in Fig. 4b. Note that while time resolution grows, the frequency resolution becomes smaller.

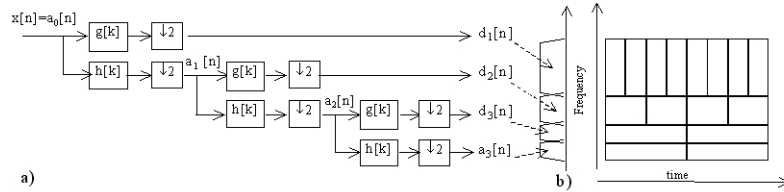

Fig. 4. Iterative FWT Mallat's algorithm (a) and its time-frequency resolution (b).

It is possible to apply a full decomposition tree instead of the Mallat algorithm (Fig. 5). Such analysis is called Wavelet Packet Decomposition. WPD is a generalization of the WT and allows more precise selection of the analyzed frequency band.

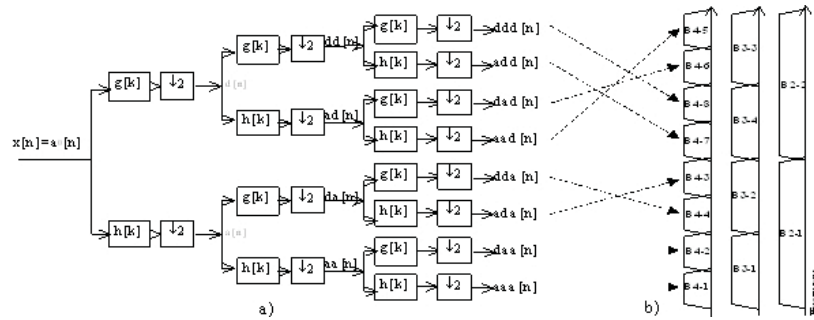

Fig. 5. WPD full tree algorithm (a) and corresponding frequency bands (b).

Formula (4) shows the method to obtain Wavelet Packet Filters on successive levels, starting from $h[k]$ and $g[k]$.

$$\begin{aligned}
 W_{2n}[t] &= \sqrt{2} \sum_{k=0}^{2N-1} h[k]W_n[2t - k] \\
 W_{2n+1}[t] &= \sqrt{2} \sum_{k=0}^{2N-1} g[k]W_n[2t - k]
 \end{aligned}
 \tag{4}$$

In WPD the natural order of filters is different than the order of frequency bands – it is the consequence of DSP properties (Fig.6.). Convolution with high-pass filter outputs high frequency part of the useful signal and its flipped copy near $F_s/2$. The applied decimation “adds” another flipped copy near to $F = 0$ and in consequence gives it as a result of the whole stage. Iterative filtering of the signal results in multiple flipping.

In most cases (for signal recognition, compression and denoising) it is not necessary to order the results of WPD on a monotonically increased frequency scale, but it can be useful for observation of the signal spectrum.

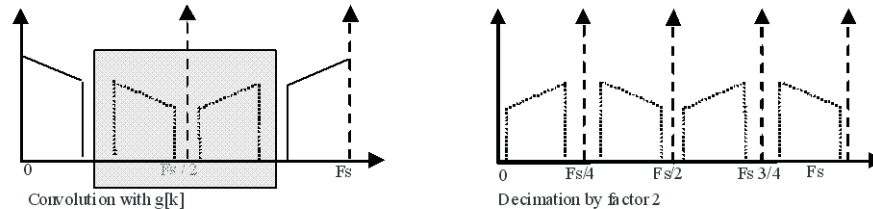

Fig. 6. Principle of high band spectrum flipping by high pass stage processing.

The more detailed signal analysis increases computation complexity. Usually it is not necessary to analyze all bands or their interdependencies, therefore one of the main matters in WPD is selection of most interesting bands – Best Tree. Most popular is the Coifman-Wickerhauser method based on the minimum entropy criterion. In paper [9] a simple algorithm using WPD Best Tree selection is proposed as a method for classification of the signals with character similar to glass breaks. Unnormalized Shanon entropy is defined by formula (5):

$$E = - \sum_n x[n]^2 \log(x[n]^2) \quad . \quad (5)$$

This criterion was also used by the authors during the research on WPD application for classification of Glass Break Acoustic Signals (GBAS). Obviously other selection criteria are known and can be used. Generally the criterion should fit the purpose.

3. METHODS OF RESEARCH

During research a set of signals obtained during real tests in Alarmtech laboratory was used. Signals were recorded with a sample rate of 100 kS/s with 2 meter distance from the glass pane being broken. From hundreds of recorded signals the authors selected a set of true and false signals. Because the most difficult for classification are acoustic signals generated when the glass is hit but not broken, mainly this kind of false signals has been used.

Acoustic signals were analyzed using the algorithm presented in Fig. 7. After A/D conversion they are formed into short (2.5 – 5 ms) overlapped frames and their energy is calculated. Every segment with energy above some fixed value is marked as “useful”, conditioned and processed

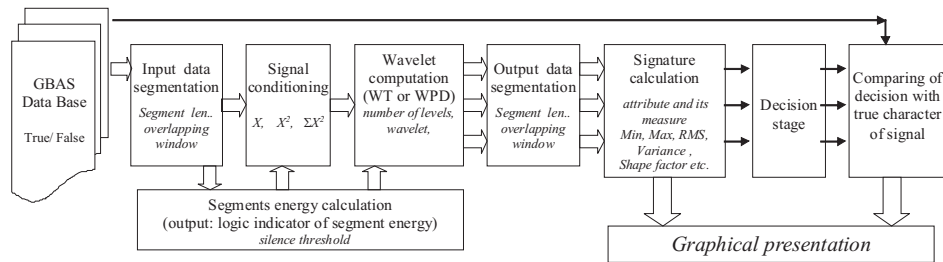

Fig. 7. Structure of basics analysis algorithm.

by the WT (or WPD) algorithm. To increase the time resolution of selected measures [3], output data segmentation (called post-segmentation) is used. Usually 16-32 samples long post-segments give the best results. To reduce the amount of data, some measure (e.g. instantaneous phase or its derivative – amplitude independent measures, real or imaginary part – amplitude sensitive) of every segment is calculated and collected creating a real-valued signal signature. In the end signals are classified as true or false using a peak criterion proposed in [3]. For research purposes the ratio of properly classified true signals to the number of true signals is calculated – called detectability, and ratio of properly classified false signal to the number of false signals – called resistance to false signals. For better description of a classification quality using a single number, its detectability reduced by the factor of wrongly classified false signals is estimated (6) and presented graphically.

$$H = \left| \frac{Pp}{Lp} - \frac{Bf}{Lf} \right| \cdot 100\%, \quad (6)$$

where Pp is the number of correctly classified true signals, Bf is the number of incorrectly classified false signals, Lp and Lf are the numbers of true and false signals respectively.

Research has been carried out in two main aspects. First – analysis of WPD usefulness for identification of GBAS using the algorithm shown in Fig. 7 and methods presented in [3]. The second aspect was the possibility of common Best Tree construction for limitation of computation complexity and possibility of application of the Coifman-Wickerhauser method for this task.

The authors used the MATLAB® environment for analysis. There were used over 900 combinations of Wavelet-Attribute-Measure sets called aggregates, with different post-segmentation length. According to results obtained for WT, only the first four levels of approximations (15 bands) were used – such a number of bands was enough

to obtain 90% detectability using WT, and the authors expected increasing method performance.

4. RESULTS

As mentioned, the main problem analyzed by the authors was the possibility of improvement of the early method [3] by application of WPD. Table 1 presents the final joined detectability obtained on the first 3 levels for Bior1.3 wavelet, and Table 2 for Bior1.5. Most of the cells have a value below 30%, and the authors decided to leave them unfilled for clearance. Because the WT algorithm presented in [3] covers bands L1-1, L2-1 and L3-1 of WPD (columns with gray background), such columns are not interesting from this point of view. Meaningful values in columns L2-2 and L3-2

Table 1. Detectability of selected aggregates of Bior1.3 (empty cells have values less than 30).

<i>Attribute</i>	<i>Measure</i>	<i>L1-1</i>	<i>L2-1</i>	<i>L2-2</i>	<i>L3-1</i>	<i>L3-2</i>	<i>L3-3</i>	<i>L3-4</i>
Phase	SHAPE -	70-90						
	SHAPE 8	p50	p50	45-60				
	SHAPE 16			50-75				
	SHAPE 32			50-60	50-70			
	MEAN -,8,16	50-70			50-70			
	MEAN 32	50-85	~ 40		50-70	p50		
ABS (Phase)	MEAN -	~ 75						
	MEAN 32				50-70			
	VAR 16	~ 50			50-75			
	MIN 16,32	50-60	~ 50					
Envelope Modulated Phase	RMS – ALL							50-70
	MAX -	~ 50		~ 50			~ 50	50-70
	MAX 8	~ 50	~ 50	~ 50			~ 50	50-70
	MAX 16	~ 50		~ 50			~ 50	50-70
	MAX 32	~ 50		~ 50			~ 50	50-70
	SHAPE 8	50-70	~ 45	~ 45				
	SHAPE 16	50-70						
Frequency	SHAPE -	50-85	50-75					
	PEAK -		~ 50	~ 50				
Imaginary part	SHAPE 8			50-75				
	VAR -				~ 50	~ 50p75	40, p50	

Table 2. Detectability of selected aggregates of Bior1.5 (empty cells have values less than 30).

<i>Attribute</i>	<i>Measure</i>	<i>L1-1</i>	<i>L2-1</i>	<i>L2-2</i>	<i>L3-1</i>	<i>L3-2</i>	<i>L3-3</i>	<i>L3-4</i>
Phase	SHAPE 8					40-50	~ 40	~ 50p80
	SHAPE 16		40-65	40 p50	~ 50			p50
	RMS -	~ 50	50 p60	~ 25				~ 40p65
	RMS 8	~ 50	~ 40	~ 45	40 p50			40-50
	RMS 16	~ 50	75	50	40-p50	40 p50		
	RMS 32	~ 50	>65 pp90					40 p60
	MEAN -	50-75	70-85					
	MEAN 8	50-55	40 p50		40 p50			~ 40p55
	MEAN 16	50-55	80-100		40 p75			50 p55
	MEAN 32	65-75	85-100					
	VAR -	50-70	50-75					
	VAR 8	~ 50						
	VAR 16	~ 50	80-95					pp45
	VAR 32	65-75	90-95					
ABS (Phase)	MIN 8		65-75		~ 40 – 45			
	MIN 16	~ 40 – 45	85-95					
Envelope	SHAPE -	50 p70	~ 50					
	SHAPE 16		~ 30p55		70 p75	~ 40	~ 40	~ 40
	SHAPE 32	50 p55	45 p55					~ 50
	RMS -							~ 50p55
	RMS 8							~ 50p70
	RMS 16,32							~ 45p60
Frequency	MEAN -				40p50		50-75	
	MEAN 8, 16				50-55	50-55	60-85	
	MEAN 32				~ 0p55		50-70	
Imaginary part	PEAK 16					60-75		
	PEAK 32					60-90		

to L3-4 indicate that WPD improves a particular aggregate. It is easy to see that for example aggregate Bior1.3-EnvelopeModulatedPhase-Maximum gives very well results in band L3-4 for all lengths of post-segments, and moreover its detectability is improved in relation to the results obtained for WT (L1-1, L2-1, L3-1). Bior1.5-Envelope-RMS

L3-4, Bior1.5-Frequency-Mean L3-3, Bior1.5-Imaginary-Peak L3-2 are also better than presented in [3]. Similarly, Bior1.3-Phase-ShapeFactor allows good classification of the signal using band L2-2.

Due to lack of space, the authors do not attach tables for other wavelets, but their analysis gives evidence that WPD makes classification of GBAS easier and more unequivocal. On the other hand it is worth to note that detectability of some very useful aggregates (e.g. Bior1.5-Phase) remains unimproved. According to the results presented in [3] it was expected that phase aggregates which gave best detectability for WT, still have very good detectability in bands L1-1, L2-1, and L3-1 of WPD. This result proves that the WPD method constitutes deployment of WT and can extract features from a greater number of narrower bands. This is very important for embedded detectors, monitoring signals on-line, where usually parameters of processing are selected arbitrarily and there is no time for detailed analysis with different settings (like wavelets, measures or post-segmentation).

Table 3 presents some improved amplitude sensitive and insensitive aggregates which give the best identification using WPD characteristic bands only. As can be seen, amplitude- insensitive parameters (like phase and frequency) usually have one meaningful band, while amplitude-sensitive parameters (like envelope, real and imaginary part) have few bands with excellent detectability. Analysing a certain position of pointed bands on the frequency scale (see Fig. 5) it is easy to see that bands 3-1 and 3-2 are parts of band 2-1, and 3-3 , 3-4 of band 2-2. Basing on this feature it is clear why particular bands occur together.

Table 3. Detectability of best WPD aggregates.

<i>Amplitude insensitive aggregates</i>	<i>L1-1</i>	<i>L2-1</i>	<i>L2-2</i>	<i>L3-1</i>	<i>L3-2</i>	<i>L3-3</i>	<i>L3-4</i>
Bior1.3 Phase – Shape Factor 16			50-75				
Bior1.3 Env. Mod. Phase – Max 16	~ 50	~ 50	~ 50			~ 50	50-70
Bior1.5 Frequency – Mean 8				50-55	50-55	60-85	
Coiflet1 ABS(Phase) – Std. Deviation –			55-65	50-65		50-65	
<i>Amplitude sensitive aggregates</i>	<i>L1-1</i>	<i>L2-1</i>	<i>L2-2</i>	<i>L3-1</i>	<i>L3-2</i>	<i>L3-3</i>	<i>L3-4</i>
Bior1.3 Imaginary – Shape Factor 8			50-75				
Coiflet1 Real RMS 32						50-55	50-65
Coiflet1 Envelope RMS 32			45-60		45-50		50-70
Coiflet1 Envelope Variance 32			50-70		45-55	<45	50-60

For contrast Table 4 presents detectability of the best Bior1.5 aggregates on the 4-th level. As can be seen there are no interesting bands and almost all results are smaller than 50%. Other wavelets gave similar weak results at this level. The authors

concluded that the first 3 iterations of WPD are enough for GBAS identification and have limited further analysis to 3 levels only (7 bands presented in Table 1).

Table 4. Detectability of some single element Bior 1.5 signatures on level 4.

<i>Measure</i>	<i>L 4-1</i>	<i>L4-2</i>	<i>L4-3</i>	<i>L4-4</i>	<i>L4-5</i>	<i>L4-6</i>	<i>L4-7</i>	<i>L4-8</i>
Variance of Phase	40-50	~ 40,p 65,	<25, p 40	<25, p 50	~ 25,p50	~ 25,	25-30	<25
Std. Dev. of Phase	45, p 60	p 70	~ 25,p 50	~ 25,p 50	<25	30-50	25-40	<25
RMS of Phase	45, p 60	p 60	<25	<25	<25, p30	25-50	<25	<25

Another very important aspect is the possibility of extracting Time-Frequency interdependences using WPD in place of WT. The only method to show these interdependences is a graphical presentation. Figure 8 shows typical time charts of true and false signals in different bands (time scale shows the number of segments, not direct time).

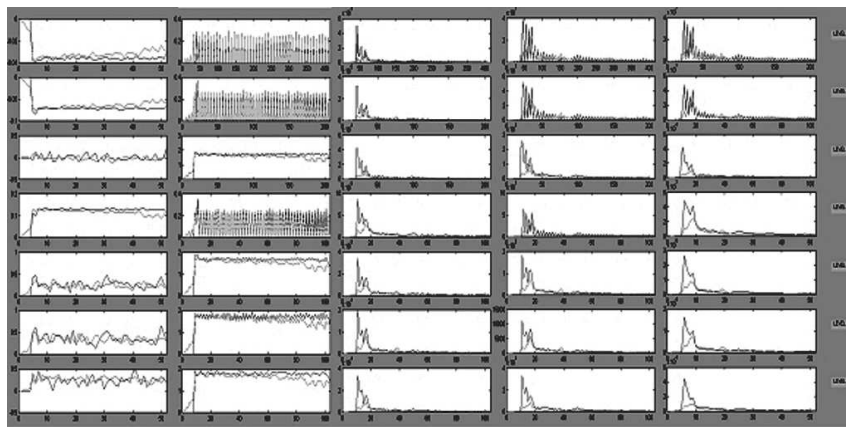

Fig. 8. Typical time charts of averaged true and false signals aggregates (100 ms) – bands 1-1 to 3-4 (from left – phase, phase with post-segmentation, envelope modulated phase, real part, imaginary part).

The first two left columns show examples of phase aggregates. However the general shape of these charts is characteristic, it is difficult to find clear differences between true and false signals. The only difference is magnitude of data, what explains the obtained detectability of single element signatures for phase aggregates (Table 1). The central and two right columns show typical amplitude-dependent aggregates – envelope, real and imaginary part. There are many clear differences between charts of true and false signals. Using these features, it is easy to construct multi-element true or false time signatures of particular bands for a selected aggregate. It is worth to note that significant differences can be observed in all bands of WPD.

The authors have tested the detectability and resistance (immunity) to false signals of some 32-element patterns based on averaged true and false real-valued signatures

of envelope, real part and imaginary part. Results show that although such simple patterns do not increase true signal detectability (resulting about 40-50%), but allow a significant improvement of resistance to false signals (usually 80-90%, sometimes up to 95%). The authors noted that the key for algorithm improvement lies not in identification of false signals, but in classification of a particular signal as not being true. Such an approach gives much better resistance than those presented in [2] and [3] but, as it was maintained, gives weak detectability of true signals.

The main disadvantage of time signatures is the need of remembering and comparing 10-20 ms records. The authors use post-segmentation to decrease the number of samples needed to be stored. Depending on the length of post-segments, a 10 ms signature consists of 32 to 128 samples. In addition amplitude aggregates are very sensitive to environment parameters (e.g. distance from the broken pane, existence of silencing materials in the room) which can be the reason of improper classification.

As mentioned in the theoretical introduction, application of WPD dramatically increases computation complexity, so it is essential to find some method for automatic selection of bands being used for identification. The authors tried to use the minimum entropy criterion to select the common Best Tree. The probabilities of node occurrence for debauches, symlet, coiflet and biorthogonal wavelets have been calculated. Table 5 shows the results for biorthogonal wavelets. To shorten the table, probabilities of 4-th level nodes are presented only. The biorthogonal family of wavelets has been selected as most suited for GBAS analysis, and in this experiment also gave the most characteristic tree.

It is easy to see that highest probabilities have nodes 3 and 4 (enclosed in band 3-1) but also other low band nodes have probabilities over 0.5 and this feature is almost independent of the wavelet. The highest frequency nodes have much lower probabilities, what suggests that upper bands do not contain any important information about the signals, or their energy is very low in relation to other bands (with biorthogonal wavelet analysis).

Table 5. Probability of node presence in Best Tree with bior. wavelets for min. entropy criterion.

8

<i>Wavelet</i>	<i>N 1-2</i>	<i>N 3-4</i>	<i>N 5-6</i>	<i>N 7-8</i>	<i>N 9-10</i>	<i>N 11-12</i>	<i>N 13-14</i>	<i>N 15-16</i>
Bior1.3	0.43	1	0.71	0.43	0.29	0.14	0.29	0
	0.87	1	0.87	0.75	0.5	0.5	0.5	0.31
Bior 1.5	0.57	1	0.86	0.71	0	0	0	0
	0.86	1	0.6	0.6	0	0	0	0
Bior 2.6	0.57	1	0.71	0.71	0.23	0	0.23	0
	0.69	1	0.69	0.12	0.06	0	0	0

The presented results match with the STFT spectrum of the phenomena [11]. Basing upon these results, an initial tree for further research was created – Fig. 9a. For comparison a WT decomposition tree is also presented. It is clear that the new tree can be seen as an extension of the basic WT tree.

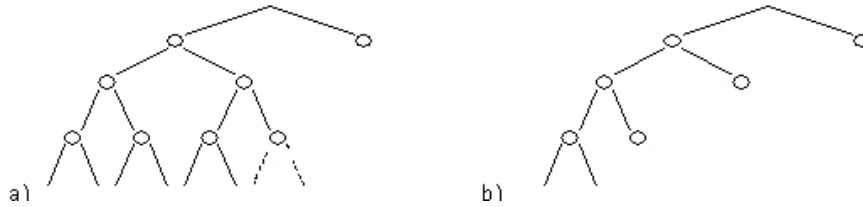

Fig. 9. WPT Best Tree created on the ground of Table 5. (a) and basic WT tree (b).

After analysis of detectability for different aggregates the authors found that there is no single characteristic tree or set of bands which guarantee proper identification, and moreover high frequency bands are very useful. The authors considered that the application of the minimum entropy criterion for BT selection is not suitable for this task. What is important, tables of probabilities were not so characteristic for other wavelets as for the biorthogonal one. Analysis of high frequency bands of different wavelets shows that they can be very useful for signal classification. Note that the main problem of GBAS identification lies not in lossless compression but in extraction of its most distinctive features. Finally, the authors used joined detectability as the Best Tree selection criterion. Such a solution guarantees selection of a tree which fits the selected aggregate, and actually consists of useful nodes only. Its main disadvantage is the fact that there is no common BT, and every combination of analysis parameters requires calculation of its own tree.

5. CONCLUSIONS

The presented results of investigation of the proposed WPD method of glass break acoustic signal detection shows that it is better than the previous method based on conventional WT. In some bands this method gives better detectability over 95% in comparison with 90% for the WT method. For a lot of other bands the WPD detectability is on the level of 60-80% in place of WT detectability under 50%.

The method improves also the resistance to false signals, what is important from the point of view of the standard of requirements. For example, the WPD method with application of a 32 element time signature improves the resistance to false signals by 10-15%, assuring a resistance of over 91%. It is a substantial progress, however the method still does not fulfill VdS standard requirements, 100% resistance to defined false signals. So, the authors are still working on further improvement of the method, via

fusion of two signal classification methods – based on phase aggregates for true signal identification, and multi-element amplitude (energy) signatures to get best resistance to false signals.

REFERENCES

1. Augustyniak P.: *Wavelet Transformations in electrodiagnostic applications*. Uczelniane Wydawnictwa Naukowo-Dydaktyczne AGH, Kraków 2003, (in Polish).
2. Bemke I., Tłaga W.: “Remote diagnostics of glass pane using Wavelet Transformation”. *Conference: Napędy i Sterowanie*, Gdańsk, February 2004, pp. 18–19, (in Polish).
3. Bemke I., Zielonko R.: „Application of Rock Solid Attributes for robust identification of glass breaks acoustic signals via Wavelet Transformation”. *10th IMECO TC10 International Conference on Technical Diagnostics*, 9-10 June, 2005, Budapest, Hungary.
4. Bemke I., Zielonko R.: „On application of Wavelet Packets Decomposition to glass breaks acoustic signal features extraction”. *16th IMEKO TC-4 Symposium 2008*, Florence, Italy, pp. 248–253.
5. Białasiewicz J. T.: *Wavelets and approximations*. WNT Warszawa 2000, (in Polish).
6. Brzyski M.: „Glass breaks detectors”. Part 1 *Zabezpieczenia*, no 6/2002 pp. 47-49, and part 2 *Zabezpieczenia*, no 1/2003, pp. 32–34, (in Polish).
7. Chien-Chang L., Shi-Huang Ch.: “Audio Classification and Categorization Based on Wavelets and Support Vector Machine”. *IEEE Transactions on Speech and Audio Processing*, vol. 13, no. 5. September 2005, pp. 644–651.
8. Kidae K., Dae Hee Youn, Chulhee L.: “Evaluation of Wavelet filters for Speech Recognition”. 0-7803-6583-6/00/\$10.00@2000 IEEE, pp. 2891–2894.
9. Łukasik E.: “Wavelet Packet based features selection for voiceless plosives classification”. 0-7803-6293-4/00/\$10.00@2000 IEEE, pp. 689–692.
10. Levent E., “Harmonic analysis Via Wavelet Packet Decomposition Using Special Elliptic Half-Band Filters”. *IEEE Transactions on Instrumentation and Measurement*, vol. 56, 2007.
11. Tłaga J., Tłaga W.: “Remote diagnostic of glass pane based on Hilbert Transformation”. *3rd International Congress of Technical Diagnostic 2004*, Poznań, Poland, (in Polish).
12. „VdS Richtlinien für Einbruchmeldeanlagen: Glasbruchmelder – Anforderungen“, VdS Schadenverhütung im Gesamtverband der Deutschen Versicherungswirtschaft e.V., VdS 2332, Köln, 2002, (in German).
13. Wojtaszczyk P.: *Wavelet theory*. PWN, Warszawa 2000, (in Polish).
14. Mallat G. S.: “A Theory for Multiresolution Signal Decomposition: The Wavelet, Representation” *IEEE Transaction on Tatteren Analysis and Machine Intelligence*, 1989, vol. 11, no 1, pp. 674–693.